



## Installation and operating instructions

- Stecamat STM 820 (12 V/24 V/36 V/48 V)  
 STM 821 (12 V/24 V/36 V/48 V)  
 STM 860 (12 V/24 V/36 V/48 V)  
 STM 861 (12 V/24 V/36 V/48 V)



## Index

<b>1</b>	<b>About this manual</b> .....	<b>3</b>
1.1	Applicability .....	3
1.2	Users .....	3
1.3	Description of symbols .....	3
<b>2</b>	<b>Safety</b> .....	<b>4</b>
2.1	Proper usage .....	4
2.2	Improper usage .....	4
2.3	Data security .....	5
2.3	Other risks .....	5
2.4	Fault behaviour .....	5
2.5	Exclusion of liability .....	5
<b>3</b>	<b>Devices with potentiometer and LED (STM 820)</b> .....	<b>6</b>
3.1	Structure .....	6
3.2	LED statuses .....	6
<b>4</b>	<b>Devices with potentiometer and LED (STM 860)</b> .....	<b>6</b>
4.1	Structure .....	6
4.2	LED statuses .....	6
<b>5</b>	<b>Devices with display (STM 821/861)</b> .....	<b>7</b>
5.1	Structure .....	7
5.2	Menu description .....	7
<b>6</b>	<b>Mounting</b> .....	<b>9</b>
6.1	Mounting location requirements .....	9
6.2	Mounting the STM 860/861 .....	9
6.3	Mounting the STM 820/821 .....	9
<b>7</b>	<b>Operation</b> .....	<b>10</b>
7.1	STM 820/860 .....	10
7.2	STM 821/861 .....	11
<b>8</b>	<b>Care, maintenance and service</b> .....	<b>11</b>
8.1	Cleaning .....	11
8.2	Maintenance and repair .....	11
<b>9</b>	<b>EMC and EMF measures</b> .....	<b>12</b>
<b>10</b>	<b>Technical data</b> .....	<b>12</b>
10.1	Device data .....	12
10.2	Battery specifications .....	13
10.3	Applicable standards .....	13
10.4	Characteristic curves .....	13
<b>11</b>	<b>Fault diagnosis and troubleshooting</b> .....	<b>15</b>
11.1	General fault diagnosis and troubleshooting .....	15
11.2	Fault diagnosis STM 820/860 .....	15
11.3	Fault diagnosis STM 821/861 .....	15
<b>12</b>	<b>Legal guarantee</b> .....	<b>16</b>
<b>13</b>	<b>Appendix</b> .....	<b>16</b>
	Glossary .....	16
<b>14</b>	<b>Contact Steca</b> .....	<b>17</b>

## Introduction

Steca STM 820, STM 821, STM 860 and STM 861 are battery chargers for lead-acid batteries. The main areas of application are battery charging rooms, workshops, depots, and the power supply of car parks.

Steca STM 820, STM 821, STM 860 and STM 861 ensure a high battery service life and minimum recharging times by means of a microprocessor-controlled charging process.

The series of battery chargers covers the following variants:

- Output voltage 12 V, 24 V, 36 V or 48 V.
- Setting of the battery capacity via a potentiometer or via menu-driven buttons with LCD display (exception: STM 860)
- Casing protection degrees IP 20 or IP 65

Type		Output voltage	Output current	Control element	Protection degree
STM 820	12 V/50 A	12 V	50 A	Potentiometer	IP 20
	24 V/35 A	24 V	35 A		
	36 V/25 A	36 V	25 A		
	48 V/18 A	48 V	18 A		
STM 821	12 V/50 A	12 V	50 A	LCD display	IP 20
	24 V/35 A	24 V	35 A		
	36 V/25 A	36 V	25 A		
	48 V/18 A	48 V	18 A		
STM 860	12 V/50 A	12 V	50 A		IP 65
	24 V/35 A	24 V	35 A		
	36 V/25 A	36 V	25 A		
	48 V/18 A	48 V	18 A		
STM 861	12 V/50 A	12 V	50 A	LCD display	IP 65
	24 V/35 A	24 V	35 A		
	36 V/25 A	36 V	25 A		
	48 V/18 A	48 V	18 A		

## 1 About this manual

These operating instructions are part of the product.

- ▶ Read these operating instructions carefully before use,
- ▶ keep them near the product during its entire service life,
- ▶ and pass them on to any future owner or user of this product.

### 1.1 Applicability

These instructions describe the function, operation, installation and dismantling of the battery chargers.

### 1.2 Users

These operating instructions are intended for end customers. A technical expert must be consulted in cases of uncertainty.

### 1.3 Description of symbols



#### 1.3.1 The structure of the warning notices

##### SIGNAL WORD

**Type, source and consequences of the danger!**

- ▶ Measures for avoiding danger

#### 1.3.2 Danger levels in warning notices

Danger level	Probability of occurrence	Consequences of non-compliance
 <b>DANGER</b>	Imminent threat of danger	Death, serious bodily injury
 <b>WARNING</b>	Possible threat of danger	Death, serious bodily injury
 <b>CAUTION</b>	Possible threat of danger	Minor bodily injury
<b>CAUTION</b>	Possible threat of danger	Property damage

### 1.3.3 Notes

#### NOTE



##### Note on easier and safer working habits

- ▶ Measures for easier and safer working habits

### 1.3.4 Other symbols and markings in this manual

Symbol	Meaning
▶	Call to action
▷	Result of action
-	Action description
•	List
<b>Emphasis on issue at hand</b>	<b>Emphasis on issue at hand</b>

### 1.3.5 Symbols and markings on the device (type plate)

Symbol	Meaning
	The device may not be disposed of in the household waste. ▶ Dispose of the device in accordance with the local regulations (e.g. collection station).
	Read the operating instructions before commissioning.

## 2 Safety

### 2.1 Proper usage

The battery chargers may only be used for charging lead-acid batteries in accordance with the specifications in these operating instructions and the battery manufacturer's charging specifications.

Transportable battery chargers of protection class I for use outdoors may only be connected to a safety socket.

Position the battery in a frost-free location. Do not start the charging process before the battery has thawed out.

Lead-acid batteries may only be charged if the acid level complies with the battery manufacturer's specifications.

#### WARNING

- ▶ Ensure that a professional electrician regularly checks the functionality of the protective conductor for the mains cable and device supply cable.
- ▶ The device may only be plugged into to a socket which has a protective conductor (grounding). Residual current protection is recommended as an additional protective measure.
- ▶ Observe mains voltage! The specifications on the charger's type plate must comply with the specifications of the local electricity grid.

### 2.2 Improper usage

The device may not be opened.

Do not use the battery chargers to charge lithium batteries, ionic batteries, NiCd batteries, NiMH batteries, or any other batteries which do not comply with the specifications of these operating instructions.

No objects which can hinder air circulation may be placed on the ventilation slots at the rear of the battery charger. The charger may not be covered when in operation.

Non-rechargeable batteries may not be charged with this device.

The battery may not be placed in a poorly ventilated room during charging (applies to battery chargers for accumulators).

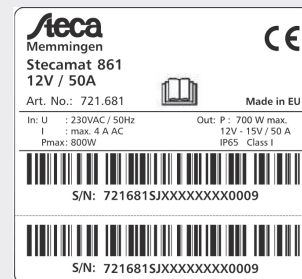

This device is not intended for use by persons (including children) with limited physical, sensory, or mental abilities, or inadequate experience and/or inadequate knowledge, unless supervised, or instructed on the use of the device, by a person responsible for their safety. Children should be supervised in order to ensure that they do not play with the device.

Lead-acid starter batteries may not be charged if the acid level is too high or too low, even if this only applies to one cell.

## 2.3 Data security

The user is responsible for the data security of changes to the factory settings. The manufacturer is not liable in the event of deleted personal settings.

## 2.3 Other risks



### ⚠ NOTE

#### Danger of fire and explosion

- ▶ Do not use the battery charger in dusty environments, in the vicinity of solvents, or where inflammable gases and vapours can occur.
- ▶ No open fires, flames or sparks in the vicinity of the batteries.
- ▶ Ensure that the room is adequately ventilated.
- ▶ Check the charging process regularly.
- ▶ Follow the charging instructions of the battery manufacturer.
- ▶ Never charge a frozen battery.
- ▶ The applicable standards for battery charging stations and battery charging rooms are to be observed.



### ⚠ NOTE

#### Battery acid

- ▶ Acid splashes on skin or clothing should be immediately treated with soap suds and rinsed with plenty of water.
- ▶ If acid splashes into the eyes, immediately rinse with plenty of water and seek medical advice.
- ▶ Ensure that the battery is in a secure and stable position, because if the battery were to tip over or fall, acid would escape.

## 2.4 Fault behaviour

In the following situations, it is dangerous to operate the battery charger and it must be disconnected from the mains immediately:

- The battery charger does not appear to function at all, even though the mains switch is on.
- The battery charger, mains cable, or charging cable is visibly damaged.
- Emission of smoke or fluid penetration occurs.
- Parts are loose.
  - ▶ In these situations, inform the manufacturer, the manufacturer's customer service, or a similarly qualified person, in order to prevent endangerment.

## 2.5 Exclusion of liability

The manufacturer can neither monitor the compliance with this manual nor the conditions and methods during the installation, operation, and usage of the battery charger. Improper installation of the system may result in damage to property and, as a consequence, bodily injury.

Therefore, we assume no responsibility or liability for loss, damage or costs which result from, or are in any way related to, incorrect installation, improper operation, or incorrect use.

Similarly, we assume no responsibility for patent right infringements or other infringements of the rights of third parties caused by usage of this battery charger.

The manufacturer reserves the right to make changes to the product, technical data or assembly and operating instructions without prior notice.

## 3 Devices with potentiometer and LED (STM 820)

### 3.1 Structure

The STM 820 battery chargers comprise the following components:

- 1 Potentiometer for setting the battery capacity
- 2 LED for indicating the operating status
- 3 Mains cable
- 4 Charging clips: red = +, black = –

### 3.2 LED statuses

Colour	Status	Meaning
Red	Permanently illuminated	Connection fault: no battery is connected, or a battery is connected with reverse polarity
Orange	Permanently illuminated	Charge: battery is being charged (main charging)
Green	Permanently illuminated	Recharge: battery is more than 90% charged end-of-charge voltage has been reached
Green	Slow flashing 1 s an, 1 s off	Trickle charging: battery is 100% charged, battery voltage is being reduced
Red	Slow flashing 1 s an, 1 s off	Battery fault: charging is interrupted, battery with too high or too low a voltage is connected, or overvoltage due to additional power supply/charger
Red	Rapid flashing 250 ms an, 250 ms off	Device fault: charging is stopped. Send the device to the manufacturer for inspection, and do not use it any longer!



Device image 820

## 4 Devices with potentiometer and LED (STM 860)

### 4.1 Structure

The STM 860 battery chargers comprise the following components:

- 1 LED for indicating the operating status
- 2 Mains cable
- 3 Charging clips: red = +, black = –
- 4 Mains switch for switching the device on and off

### 4.2 LED statuses

Colour	Status	Meaning
Red	Permanently illuminated	Connection fault: no battery is connected, or a battery is connected with reverse polarity
Orange	Permanently illuminated	Charge: battery is being charged (main charging)
Green	Permanently illuminated	Recharge: battery is more than 90% charged end-of-charge voltage has been reached
Green	Slow flashing 1 s an, 1 s off	Trickle charging: battery is 100% charged, battery voltage is being reduced
Red	Slow flashing 1 s an, 1 s off	Battery fault: charging is interrupted, battery with too high or too low a voltage is connected, or overvoltage due to additional power supply/charger
Red	Rapid flashing 250 ms an, 250 ms off	Device fault: charging is stopped. Send the device to the manufacturer for inspection, and do not use it any longer!



Device image 860



Device image 821



Device image 861

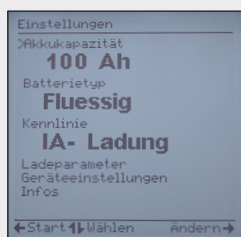

Start screen

## 5 Devices with display (STM 821/861)

### 5.1 Structure

The STM 821/861 battery chargers comprise the following components:

- Display screen for setting and displaying the operating status
- Cursor buttons for operation and adjustment
- Power connection, plug with grounding contact
- Charging clips: red = +, black = -





### 5.2 Menu description

After the device is switched on, device data appears briefly, then the main screen appears, with the most recently saved settings.

- Status row
- Data field
- Indication of the selected parameters
- Operating guide row

#### 5.2.1 Functions of the cursor buttons

The present function of the cursor buttons are shown in the bottom row of the display.

-   Select parameter/change value
-  Change parameter/save setting
-  In menu: go back without saving  
In start screen: start/stop charging process

#### 5.2.2 Adjusting settings

**Example: adjusting the displayed battery capacity**

- ▶ Make sure that the parameter "Battery capacity" is marked with the symbol ">". If necessary, select this parameter with the up/down buttons.
- ▶ Activate the "Battery capacity" parameter with >.
- ▶ Adjust the value with up/down.
- ▶ Once the desired value has been reached, save it with >, or press < to return to the previous menu without saving.

#### 5.2.3 Menu overview

The menu contains the following items:

- Battery capacity
- Battery type
- Characteristic curve
- Charge parameters
- Device settings
- Info

The following sections describe the menu items in detail.

#### Battery capacity

With the up/down buttons, the battery capacity can be adjusted within the permissible capacity limits.

#### Battery type

The following battery types can be selected with the up/down buttons:

- Liquid battery
- Gel battery

### Selecting a characteristic curve

The following characteristic curves can be selected with the up/down buttons:

- IU charging
- IA charging
- Constant U charging
- On-off

More detailed information on the characteristic curves can be found in the "Technical data" chapter.

### Charge parameters

The "Charge parameters" menu contains the following submenus:

- End-of-charge voltage  
With the up/down buttons, the end-of-charge voltage can be adjusted within the permissible voltage limits.  
Factory settings: 14.4 V for 12 V variant; 28.8 V for 24 V variant; 43.2 V for 36 V variant; 57.6 V for 48 V variant
- Trickle voltage  
With the up/down buttons, the trickle voltage can be adjusted within the permissible voltage limits.  
Factory settings: 13.8 V for 12 V variant; 27.6 V for 24 V variant; 41.4 V for 36 V variant; 55.2 V for 48 V variant
- Charging current factor  
With the up/down buttons, the contrast of the display can be adjusted between 0.1 .... 1.0 \*C.  
Factory setting: 0.3 \*C  
**Example:** with charging current factor 0.3 \*C, the charging current for a 100 Ah battery is 30 A.
- Temperature compensation  
If temperature compensation is switched on, the end-of-charge voltage is reduced in high temperatures, and increased in low temperatures.  
Factory setting: temperature compensation switched off

### Device settings

The "Device settings" menu contains the following submenus:

- Brightness  
With the up/down buttons, the brightness of the display can be adjusted between 0 and 100%.  
Factory setting: 50%
- Contrast  
With the up/down buttons, the contrast of the display can be adjusted between 0 and 100%.  
Factory setting: 50%
- Permanent illumination  
If permanent illumination is switched off, the brightness of the display is reduced if approximately 15 seconds pass without any action occurring. The next time a button is pressed, the display returns to normal brightness.  
Factory setting: permanent illumination switched off
- Language selection  
The device's language can be set to German or English.  
Factory setting: German
- Factory settings  
In this menu, you can reset all device settings to the factory settings.

### Info

In this menu, you can display the device data.

This information is also displayed briefly after the device is switched on.



## 6 Mounting

### 6.1 Mounting location requirements

- The Steca battery chargers STM 820, STM 821, STM 860 and STM 861 must be mounted on the wall in a vertical (standing) position. The deviation from the plumb line may not exceed 15°.
- The background must be even, and must not be easily flammable, e.g. concrete or stone.
- In order to guarantee circulation at the rear of the casing, there must be clearance of at least 20 cm above and below.
- Mount in the vicinity of a mains power socket. The mains cable has a length of 1.7 m.
- STM 820/821 must be mounted in enclosed rooms.
- STM 860/861 may be mounted outdoors.

#### Safety instruction

- ▶ Do not open the device.



#### **⚠ WARNING**

**Risk of electrical shock and fire due to cables coming loose!**

- ▶ Make sure that no tension is applied to the mains cables or charging cables.

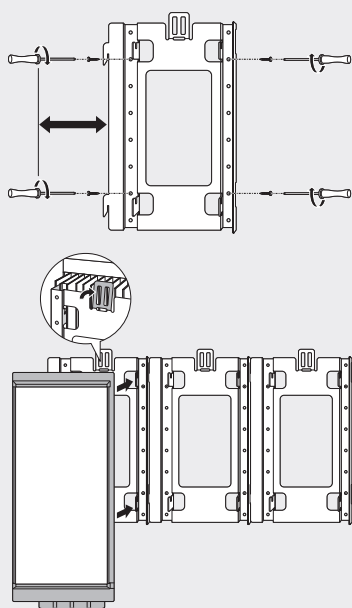

### 6.2 Mounting the STM 860/861

- ▶ Attach the mounting plate to the wall with four M5 screws (not provided).
- ▶ Allow the device to slide down from above, onto the hooks which project out at the front. In so doing, make sure that the locking mechanism drops over the cooling plate fins.
  - ▷ *This secures the device and prevents it from falling.*
- ▶ Check that the device is mounted correctly.
  - ▷ *The cooling fin furthest on the right must drop over the edge rising up on the fixing plate.*
- ▶ Plug in the mains plug.



### 6.3 Mounting the STM 820/821

#### **⚠ CAUTION**

**Risk of injury and damage to the casing when drilling!**

- ▶ Do not use the casing as a drilling template.
- ▶ Mark the upper two fastening holes.
- ▶ Drill holes and screw in the screws.
- ▶ Hang the device on the upper screws.
- ▶ Mark the lower two fastening holes.
- ▶ Remove the device again.
- ▶ Drill the lower holes.
- ▶ Hang the device on the upper screws again.
- ▶ Screw the device firmly in place at the lower holes.
- ▶ Plug in the mains plug.

## 7 Operation

### 7.1 STM 820/860

#### WARNING

##### Danger of explosion from sparking!

- ▶ When connecting and disconnecting the battery, make sure that the battery charger is switched off.
- ▶ Make sure that the battery to be charged complies with the battery charger's specifications.

#### NOTE

- ▶ The power cable and the connection cables to the battery must not be subjected to tension, be kinked, or laid over sharp edges under any circumstances.

- ▶ STM 820: turn the potentiometer (Figure 1) all the way to the left.  
STM 860: switch off the device with the mains switch (Figure 2).
- ▶ Connect the charging clips to the battery:
  - Red: + pole, black: - pole
- ▶ STM 820: set the potentiometer to the capacity of the battery to be charged. STM 860: switch on the device with the mains switch.
 

**Exception: for material handling vehicles and bus depots, the mains switch does not need to be operated because the battery detection system ensures that the battery is disconnected from the charger.**

  - ▷ The charging process starts.
  - ▷ When the LED shines green, the battery is more than 90% charged.
  - ▷ When the LED slowly flashes green, the battery is 100% charged. Trickle charging is being realised by the device.
    - Trickle charging can continue for any length of time.
- ▶ STM 820: turn the potentiometer (Figure 1) all the way to the left.  
STM 860: switch off the device with the mains switch.
- ▶ Disconnect the charging clips from the battery.

#### 7.1.1 Operation of battery chargers for the charging of vehicle batteries

- ▶ It is recommended to disconnect the vehicle battery from the on-board power supply, so as to prevent the vehicle's electronics from being damaged. Please note that upon disconnection of the battery, all of the body control units' volatile memories lose their saved data. In this event, it may be necessary to re-enter data for the following: radio code, vehicle clock, timer, on-board computer, seat position, etc.
- ▶ The battery terminal which is not connected to the car body is to be connected first. The other connection is to be attached to the car body, far from the battery and the petrol pipe. The battery charger is then to be connected to the mains.
- ▶ After charging, the battery charger is to be disconnected from the mains. The connection to the car body is then to be removed, followed by the connection to the battery.



Figure 1

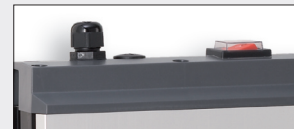

Figure 2



## 7.2 STM 821/861

### WARNING

#### Danger of explosion from sparking!

- ▶ When connecting and disconnecting the battery, make sure that the battery charger is not charging: "<Start" is shown in the bottom row of the display.
- ▶ Make sure that the battery to be charged complies with the battery charger's specifications.

### NOTE

- ▶ The power cable and the connection cables to the battery must not be subjected to tension, be kinked, or laid over sharp edges under any circumstances.
  - ▶ Switch on the device with the mains switch (STM 861 only).
  - ▶ Check whether the settings displayed in the start screen match the battery to be charged.
  - ▶ If not, correct the settings as described in section 5.2.2
  - ▶ Make sure that no charging process has yet started:
    - "<Start" is shown in the bottom row of the display.
  - ▶ Otherwise, stop the charging process with <.
  - ▶ Connect the charging clips to the battery:
    - Red: + pole, black: - pole
  - ▶ Stop the charging process with the < button.
    - ▷ The charging voltage, charging current, and battery capacity are displayed continually.
    - ▷ Once 90% capacity has been reached, "Recharge" is displayed.
    - ▷ Once 100% capacity has been reached, "Trickle charge" is displayed.
      - Trickle charging can continue for any length of time.
  - ▶ Stop the charging process with the < (stop) button.
  - ▶ Disconnect the charging clips from the battery.
  - ▶ Switch off the device with the mains switch (STM 861 only).

## 8 Care, maintenance and service

The device is maintenance-free. If functional faults occur, please consult your dealer and present the payment receipt/invoice.

### 8.1 Cleaning

- ▶ Pull the mains plug before cleaning.
- ▶ Regularly clean the outside of the casing with a damp cloth. Do not use solvents.
- ▶ Ensure that the ventilation slots at the rear of the device are not obstructed and that the air can circulate freely. If necessary, remove dust by vacuuming.

### 8.2 Maintenance and repair

Under normal operating conditions, the device's care and maintenance requirements are minimal. However, some points must be observed in order to ensure that the device remains operational for many years.

- ▶ Check the mains plug, mains cable, charging cables, and charging terminals for damage before each use.

Repair work and servicing may only be performed by an authorised specialist. Only use original replacement parts and wearing parts (this also applies to standard parts). It cannot be guaranteed that third-party components are constructed and produced in accordance with operational demands and safety requirements.

Do not modify or convert the device, or install any components in the device, without approval from the manufacturer.

## 9 EMC and EMF measures

It is the operator's responsibility to ensure that no electrical or electronic equipment is subjected to electromagnetic interference.

### WARNING

This is a class A device. This device can cause radio interference in living areas. In this event, the operator may be required to take appropriate measures.



## 10 Technical data

### 10.1 Device data

Technical data	Stecamat 800
Features	Primary switched-mode power supply with active PFC Permanently short-circuit-proof outputs with reverse polarity protection Detection of loading circuit interruption to reduce sparking
Control elements	STM 820/860: Potentiometer STM 821/861: display with membrane keypad
Input voltage range	207 VAC to 265 VAC
Output voltage variants	12 V, 24 V, 36 V, 48 V
Charging capacity	12 V variant: max. 600 W 24 V variant: max. 840 W 36 V variant: max. 840 W 48 V variant: max. 840 W
Characteristic curves	STM 820/860: IU STM 821/861: IU, IA, constant U, on-off
Duration of the charging process	Approx. 4 h for 100 Ah battery with 30 A charging current
Operating temperature	STM 820/860: -40 °C to +60 °C STM 821/861: -20 °C to +60 °C
Storage temperature	STM 820/860: -20 °C to +85 °C STM 821/861: -20 °C to +85 °C
Max. input current	5 A
Max. power consumption	1.2 kW
Dimensions (L x W x H)	STM 860/861: 550 x 250 x 150 mm STM 820/821: 430 x 250 x 130 mm
Weight	STM 860/861: 11.5 kg STM 820/821: 6.5 kg
Protection degree	STM 820/821: IP 20, for use in dry environments STM 860/861: IP 65, for use outdoors
Options	Connection of an external temperature sensor for the battery temperature Sense lines for compensation of voltage drops in connection cables
Efficiency	12 V variant: 91% 24 V variant: 93% 36 V variant: 93% 48 V variant: 93%

## 10.2 Battery specifications

STM 8.. devices are intended for charging the following batteries at any state of charge:

- Open and sealed lead-acid batteries
- Leaded lead-acid batteries (gel batteries, absorbed glass mat batteries)
- Capacities from 20 Ah to 600 Ah

## 10.3 Applicable standards

See declaration of conformity in appendix.

## 10.4 Characteristic curves

### 10.4.1 IU characteristic curve

#### IU - characteristic curve (UoIUoIU)

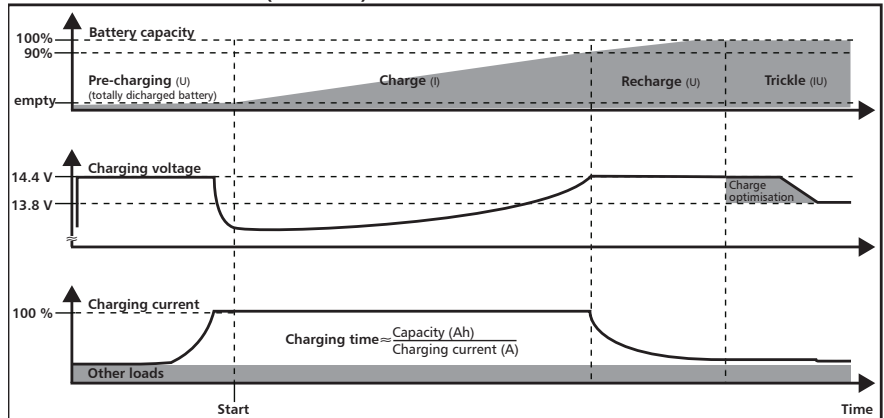

IU characteristic curve for the 12 V variant with factory settings

1. Pre-charging with end-of-charge voltage (only with totally discharged batteries)
2. Charging with constant charging current, charging voltage increases
3. Recharging with end-of-charge voltage, charging current decreases
4. Trickle charging

### 10.4.2 IA characteristic curve

#### IA - characteristic curve (UoIUoIU)

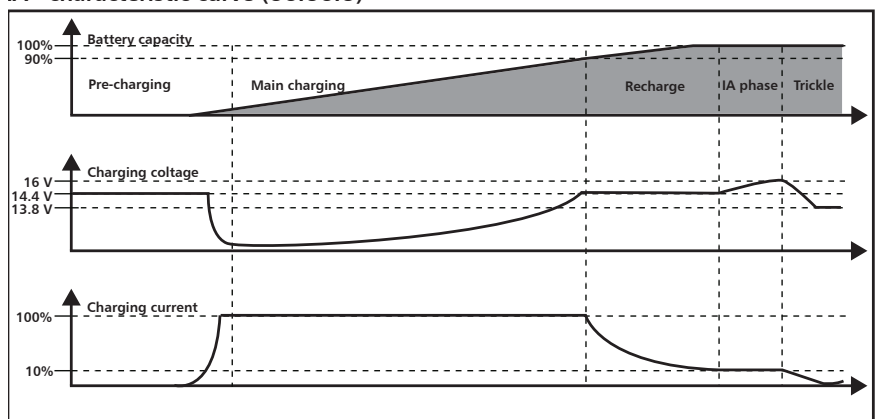

IA characteristic curve for the 12 V variant with factory settings

1. Pre-charging with end-of-charge voltage (only with totally discharged batteries)
2. Charging with constant charging current, charging voltage increases
3. Recharging with end-of-charge voltage, charging current decreases
4. IA phase with 10% of the end-of-charge current and unlimited charging voltage
5. Trickle charging

The IA phase prevents or reverses sulphation of the battery.

### 10.4.3 Constant U charging

#### Constant U charging (IU)

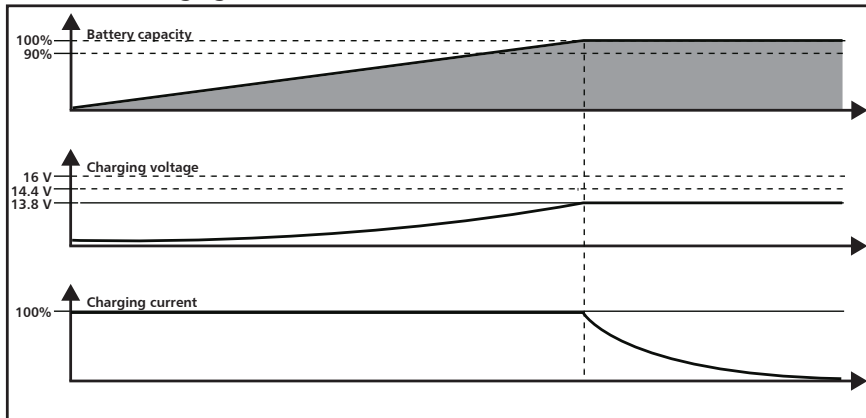

Constant U characteristic curve for the 12 V variant with factory settings

The trickle charge voltage is defined, and is maintained throughout the entire charging process.

The charging current is also defined according to the battery capacity (charging current = battery capacity \* charging current factor).

This setting is suitable for back-up operation, e.g. to supply power to vehicles in exhibition rooms, or for uninterruptible power supplies.

### 10.4.4 On-off charging

#### On-off - Characteristic curve

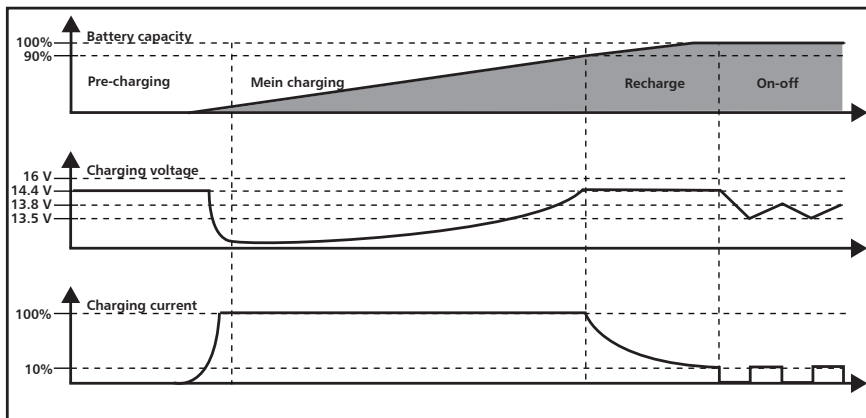

On-off charging characteristic curve for the 12 V variant with factory settings

1. Pre-charging with end-of-charge voltage (only with totally discharged batteries)
2. Charging with constant charging current, charging voltage increases
3. Recharging with charging voltage, charging current decreases
4. Trickle charging

## 11 Fault diagnosis and troubleshooting

### 11.1 General fault diagnosis and troubleshooting

Fault	Cause	Remedy
<b>Device cannot be switched on</b>	<ul style="list-style-type: none"> <li>No mains voltage</li> <li>Device fault</li> </ul>	<ul style="list-style-type: none"> <li>▶ Connect the device to the mains.</li> <li>▶ Send the device to the manufacturer for inspection.</li> <li>▶ Stop using the device!</li> </ul>
<b>Charging process takes longer than usual</b>	<ul style="list-style-type: none"> <li>Derating active due to high ambient temperatures or poor circulation</li> <li>Parallel loads</li> </ul>	<ul style="list-style-type: none"> <li>▶ Ensure sufficient circulation at the rear of the device, and, if necessary, remove any dust by vacuuming.</li> <li>▶ Remove parallel loads</li> </ul>

### 11.2 Fault diagnosis STM 820/860

Fault	Cause	Remedy
<b>LED permanently red</b>	<ul style="list-style-type: none"> <li>No battery connected</li> <li>Totally discharged battery connected (voltage &lt; 2 V)</li> <li>Battery connected with reverse polarity</li> </ul>	<ul style="list-style-type: none"> <li>▶ Connect the battery.</li> <li>▶ Disconnect the battery and check polarity.</li> </ul>
<b>LED slowly flashes red</b>	<ul style="list-style-type: none"> <li>Battery fault</li> <li>Max. battery capacity has been reached</li> <li>Battery with too high or too low a voltage is connected</li> <li>Overvoltage due to additional power supply/charger</li> </ul>	<ul style="list-style-type: none"> <li>▶ Check the battery.</li> <li>▶ Set the capacity correctly.</li> <li>▶ Check the battery. Disconnect other loads.</li> <li>▶ Disconnect the battery. The battery charger is not suitable for this battery.</li> <li>▶ Disconnect the additional power supply/charger.</li> </ul>
<b>LED quickly flashes red</b>	<ul style="list-style-type: none"> <li>Device fault</li> </ul>	<ul style="list-style-type: none"> <li>▶ Send the device to the manufacturer for inspection.</li> <li>▶ Stop using the device!</li> </ul>

### 11.3 Fault diagnosis STM 821/861

STM 821/861 devices display fault messages in plain text.

During charging, an info screen which displays additional device data (e.g. temperatures) can be opened with the down (more) button.

Fault message	Cause	Remedy
<b>Device fault</b>	<ul style="list-style-type: none"> <li>Hardware defective</li> </ul>	<ul style="list-style-type: none"> <li>▶ Send the device to the manufacturer for inspection.</li> <li>▶ Stop using the device!</li> </ul>
<b>Overvoltage</b>	<ul style="list-style-type: none"> <li>Wrong battery connected</li> <li>Additional power supply/charger connected</li> </ul>	<ul style="list-style-type: none"> <li>▶ Disconnect the battery. The battery charger is not suitable for this battery (battery voltage too high).</li> <li>▶ Disconnect the additional power supply/charger.</li> </ul>
<b>Battery fault</b>	<ul style="list-style-type: none"> <li>Maximum capacity charged</li> </ul>	<ul style="list-style-type: none"> <li>▶ Correct the battery capacity setting.</li> <li>▶ Check the battery.</li> <li>▶ Disconnect other loads.</li> </ul>

## 12 Legal guarantee

In accordance with German statutory regulations, there is a legal guarantee on this product for the customer.

The seller will remove all manufacturing and material faults that occur in the product during the guarantee period and affect the correct functioning of the product. Natural wear and tear does not constitute a malfunction. No legal guarantee can be offered if the fault can be attributed to third parties, unprofessional installation or commissioning, incorrect or negligent handling, improper transport, excessive loading, use of improper equipment, faulty construction work, unsuitable construction location or improper operation or use. Legal guarantee claims shall only be accepted if notification of the fault is provided immediately after it is discovered. Guarantee claims are to be directed to the seller.

**The seller must be informed before guarantee claims are processed. For processing a guarantee claim an exact fault description and the invoice/delivery note must be provided.**

The seller can choose to fulfil the legal guarantee either by repair or replacement. If the product can neither be repaired nor replaced, or if this does not occur within a suitable period in spite of the specification of an extension period in writing by the customer, the reduction in value caused by the fault shall be replaced, or, if this is not sufficient taking the interests of the end customer into consideration, the contract is cancelled.

Any further claims against the seller based on this legal guarantee obligation, in particular claims for damages due to lost profit, loss-of-use or indirect damages are excluded, unless liability is obligatory by law.

## 13 Appendix

### Glossary

A number of specialist terms are used in this manual which are briefly explained as follows:

<b>Charging current factor</b>	Ratio of the maximum charging current to the set battery capacity. A charging current factor of 0.3 with 100 Ah means that the charging current is $0.31 \text{ A/Ah} \times 100 \text{ Ah} = 30 \text{ A}$ .
<b>Pre-charging</b>	Pre-charging reduces sulphation in damaged batteries, and is activated if batteries have a low voltage upon connection of the charger, and only accept a low current after charging begins.
<b>Main charging</b>	In this phase, the battery is charged to approximately 90% of its capacity with the set maximum current.
<b>Recharging</b>	Once the end-of-charge voltage is reached, recharging begins, in which the battery is charged to 100% of its rated capacity.
<b>Charge optimisation</b>	This causes acid restratification and thus equalises the acid density in the individual cells of a battery.
<b>Trickle charging</b>	After charging has finished, trickle charging keeps the battery fully charged for as long as it is connected to the charger.



## 14 Contact Steca

In the event of complaints or faults, please contact the seller from whom you purchased the product. They will help you with any issues you may have.

### Europe

Steca Elektronik GmbH  
Mammostrasse 1  
87700 Memmingen  
Germany

Tel. +49 (0)8331 8558 0  
Fax +49 (0)8331 8558 132  
Email ladesysteme@steca.com

### Battery charger

Type .....

Series number .....

### Dealer

Company .....

Contact person .....

Street and number .....

Postcode .....

Town .....

Telephone number .....

Email .....

### Comments

.....  
.....  
.....  
.....  
.....  
.....  
.....  
.....  
.....  
.....  
.....  
.....  
.....  
.....  
.....  
.....  
.....  
.....  
.....  
.....  
.....



EU – KONFORMITÄTSERKLÄRUNG  
 EC – DECLARATION OF CONFIRMITY  
 DECLARATION DE CONFORMITE DE LA CE

Die Firma  
 The company  
 La société



Steca Elektronik GmbH  
 Mammostraße 1  
 87700 Memmingen  
 Germany  
 www.steca.com

Zertifikat/ Certificat/ Certificat Nr.

002-0808

erklärt in alleiniger Verantwortung, dass folgendes Produkt  
 hereby certifies on its responsibility that the following product  
 se déclare seule responsable du fait que le produit suivant

STM 820 12V, 24V, 36V, 48V  
 STM 821 12V, 24V, 36V, 48V  
 STM 860 12V, 24V, 36V, 48V  
 STM 861 12V, 24V, 36V, 48V  
 STM 862 24V  
 STM 890 12V, 24V, 36V, 48V  
 STM 891 12V, 24V, 36V, 48V

auf das sich diese Erklärung bezieht, mit folgenden Richtlinien bzw. Normen übereinstimmt.  
 which is explicitly referred to by this Declaration meet the following directives and standard(s).  
 qui est l'objet de la présente déclaration correspondent aux directives et normes suivantes.

Elektromagnetische Verträglichkeit – Richtlinie  
 Electromagnetic Compability – Directive  
 Compatibilité électromagnétique – Directive

2004/108/EG

Niederspannungsrichtlinie  
 Low Voltage Directive  
 Directive de basse tension

2006/95/EG

CE – Kennzeichnungsrichtlinie  
 CE – Marking directive  
 Directive de Identification CE

93/68/EWG

Europäische Normen <sup>1) (2/2)</sup>  
 European Standard  
 Norme européenne

EN 55 014-1:2006

EN 55 022:2006 Class A  
 A1:2007

EN 61 000-3-2:2006

EN 61 000-3-3:1995  
 A1:2001 A2:2005

EN 61 000-4-1:2007

EN 61 000-4-2:1995  
 A1:1998 A2:2001

EN 61 000-4-3:2006

EN 61 000-4-4:2004

EN 61 000-4-5:2006

EN 61 000-4-6:1996  
 A1:2001

EN 61 000-4-11:2004

EN 60 335-1:2002  
 A11:2004 A1:2004 A12:2006  
 Corrigendum:2006 A2:2006

Die oben genannte Firma hält Dokumentationen als Nachweis der Erfüllung der Sicherheitsziele und die wesentlichen Schutzanforderungen zur Einsicht bereit.

Documentation evidencing conformity with the requirements of the Directives is kept available for inspection at the above company.

En tant que preuve de la satisfaction des demandes de sécurité la documentation peut être consultée chez la société sousmentionnée.

Memmingen, 2008-08-06

Dietmar Voigtsberger, Geschäftsführung



# EU – KONFORMITÄTSEKTLÄRUNG

## EC – DECLARATION OF CONFIRMITY

### DECLARATION DE CONFORMITE DE LA CE

STM 820 12V, 24V, 36V, 48V  
STM 861 12V, 24V, 36V, 48V

#### BG

**Декларация за съответствие на европейските норми**  
С настоящето декларираме, че посочените на страницата 1 продукти, отговарят на следните норми и директиви:

Електромагнитна устойчивост 2004/108/EG  
поправки 93/68/EGW

директива за ниско напрежение – 2006/95/EG  
оправки 93/68/EGW

Приложими съгласувани стандарти и норми в частност:<sup>1)</sup>

#### EE

##### EL vastavusavaldus

Käesolevaga avaldame, et nimetatud toode on kooskõlas järgmistele direktiivide ja standarditega:

Elektromagnetilise ühilduvuse direktiiv 2004/108/EG,  
määrust 93/68/EGW

Madalpingedirektiiv 2006/95/EG, määrust 93/68/EGW  
Kohaldatud Euroopa standardid, eelkõige:<sup>1)</sup>

#### GR

##### Δήλωση προσαρμογής στις προδιαφές της Ε.Ε. (Ευρωπαϊκής Ένωσης)

Δηλώνουμε ότι το προϊόν αυτό σ' αυτή την κατάσταση παράδοσης ικανοποιεί τις ακόλουθες διατάξεις:

Ηλεκτρομαγνητική συμβατότητα 2004/108/EG όπως τροποποιήθηκε 93/68/EGW

Οδηγία χαμηλής τάσης 2006/95/EG όπως τροποποιήθηκε 93/68/EGW

Εναρμονισμένα χρησιμοποιούμενα πρότυπα, ιδιαίτερα:<sup>1)</sup>

#### LT

##### Atitikties pareiškimas su Europos Sąjungoje galiojančiomis normomis

Šiuo mes pareiškiamo, kad nurodytas gaminyo atitinka sekancias direktyvas bei normas:

Elektromagnetinio suderinamumo direktyva 2004/108/EG, ženklinimas 93/68/EGW

Žemosios įtampos direktyva 2006/95/EG, ženklinimas 93/68/EGW

Naudojamas Europoje normas, ypač:<sup>1)</sup>

#### NO

##### EU-Overensstemmelseserklæring

Vi erklærer hermed at denne enheten i utførelse som levert er i overensstemmelse med følgende relevante bestemmelser:

EG-EMV-Elektromagnetisk kompatibilitet 2004/108/EG med senere tilføyelser: 93/68/EGW

EG-Lavspenningsdirektiv 2006/95/EG med senere tilføyelser: 93/68/EGW

Anvendte harmoniserte standarder, særlig:<sup>1)</sup>

#### RO

##### Declarație de conformitate UE

Prin prezenta se declară că produsul mai sus menționat este în conformitate cu următoarele directive, respectiv norme:

Compatibilitate electromagnetică 2004/108/EG, marcaj 93/68/EGW

Directiva CE referitoare la tensiunile joase 2006/95/EG, marcaj 93/68/EGW

Norme europene utilizate, în special:<sup>1)</sup>

#### SI

##### EU-izjava o skladnosti

Izjavljamo, da je navedeni izdelek skladen z naslednjimi direktivami oz. standardi:

Direktiva o elektromagnetni združljivosti 2004/108/EG, oznaka v skladu z 93/68/EGW

Direktiva o nizkonapetostni opremi: 2006/95/EG, oznaka v skladu z 93/68/EGW

Uporabljene evropski standardi, še posebej:<sup>1)</sup>

STM 821 12V, 24V, 36V, 48V  
STM 862 24V

#### CZ

##### Prohlášení o shodě EU

Prohlašujeme tímto, že tento agregát v dodaném provedení odpovídá následujícím příslušným ustanovením:

Směrnicí EU-EMV 2004/108/EG ve sledu 93/68/EGW

Směrnicí EU-nízké napětí 2006/95/EG ve sledu 93/68/EGW

Použitě harmonizační normy, zejména:<sup>1)</sup>

#### ES

##### Declaración de conformidad CE

Por la presente declaramos la conformidad del producto en su estado de suministro con las disposiciones pertinentes siguientes:

Compatibilidad electromagnética 2004/108/EG modificada por 93/68/EGW

Directiva sobre equipos de baja tensión 2006/95/EG modificada por 93/68/EGW

Normas armonizadas adoptadas, especialmente:<sup>1)</sup>

#### HU

##### EK. Azonossági nyilatkozat

Ezennel kijelentjük, hogy az berendezés az alábbiaknak megfelel:

Elektromágneses zavarás/tűrés: 2004/108/EG és az azt kiváltó 93/68/EGW

Kisfeszültségű berendezések irány-Elve: 2006/95/EG és az azt kiváltó 93/68/EGW

Felhasznált harmonizált szabványok, különösen:<sup>1)</sup>

#### LV

##### ES Atbilstības deklarācija

Paziņojam, ka minētais izstrādājums atbilst sekojošām direktīvām jeb normām:

2004/108/EG Par elektromagnētisko panesamību, apzīmējums 93/68/EGW

2006/95/EG Direktīvai par zemspriegumu, apzīmējums 93/68/EGW

Izmantotās Eiropas normas, īpaši:<sup>1)</sup>

#### PL

##### Deklaracja zgodności CE

Niniejszym deklarujemy z pełną odpowiedzialnością że dostarczony wyrób jest zgodny z następującymi dokumentami:

Odpowiedniść elektromagnetyczna

2004/108/EG ze zmianą 93/68/EGW

Normie niskich napięć 2006/95/EG ze zmianą 93/68/EGW

Wyroby są zgodne ze szczegółowymi normami zharmonizowanymi:<sup>1)</sup>

#### RU

##### Декларация о соответствии Европейским нормам

Настоящим документом заявляем, что данный агрегат в его объеме поставки соответствует следующим нормативным документам:

Электромагнитная устойчивость 2004/108/EG с поправками 93/68/EGW

Директивы по низковольтному напряжению 2006/95/EG с поправками 93/68/EGW

Используемые согласованные стандарты и нормы в частности:<sup>1)</sup>

#### SK

##### Prehlásenie o zhode ES

Týmto prehlasujeme, že sa uvedený produkt zhoduje s nasledovnými smernicami príp. normami:

Elektromagnetická zlučiteľnosť 2004/108/EG, označenie 93/68/EGW

Smernica o nízkom napätí 2006/95/EG, označenie 93/68/EGW

Použitě európske normy, predovšetkým:<sup>1)</sup>

STM 860 12V, 24V, 36V, 48V  
STM 890 12V, 24V, 36V, 48V  
STM 891 12V, 24V, 36V, 48V

#### DK

##### EF-overensstemmelseserklæring

Vi erklærer hermed, at denne enhed ved levering overholder følgende relevante bestemmelser:

Elektromagnetisk kompatibilitet: 2004/108/EG, følgende 93/68/EGW

Lavvolts-direktiv 2006/95/EG følgende 93/68/EGW

Anvendte harmoniserede standarder, særligt:<sup>1)</sup>

#### FI

##### CE-standardinmukaisuusseloste

Ilmoitamme täten, että tämä laite vastaa seuraavia asiaankuuluvia määräyksiä:

Sähkömagneettinen soveltuvuus 2004/108/EG seuraavin täsmennyksin 93/68/EGW

Matalajännite direktiivi: 2006/95/EG seuraavin täsmennyksin 93/68/EGW

Käytetyt yhteensovitett standardit, erityisesti:<sup>1)</sup>

#### IT

##### Dichiarazione di conformità CE

Con la presente si dichiara che i presenti prodotti sono conformi alle seguenti disposizioni e direttive rilevanti:

Compatibilità elettromagnetica 2004/108/EG e seguenti modifiche 93/68/EGW

Direttiva bassa tensione 2006/95/EG e seguenti modifiche 93/68/EGW

Norme armonizzate applicate, in particolare:<sup>1)</sup>

#### NL

##### EU-verklaring van overeenstemming

Hiermede verklaren wij dat dit aggregaat in die geleverde uitvoering voldoet aan de volgende bepalingen:

Elektromagnetische compatibiliteit 2004/108/EG als vervolg op 93/68/EGW

EG-laagspanningsrichtlijn 2006/95/EG als vervolg op 93/68/EGW

Gebruikte geharmoniseerde normen, in het bijzonder:<sup>1)</sup>

#### PT

##### Declaração de Conformidade CE

Pela presente, declaramos que esta unidade no seu estado original, está conforme os seguintes requisitos:

Compatibilidade electromagnética 2004/108/EG com os aditamentos seguintes 93/68/EGW

Directiva de baixa voltagem 2006/95/EG com os aditamentos seguintes 93/68/EGW

Normas harmonizadas aplicadas, especialmente:<sup>1)</sup>

#### SE

##### CE-försäkran

Härmed förklarar via tt denna maskin i levererat utförande motsvarar följande tillämpliga bestämmelser:

EG-Elektromagnetisk kompatibilitet 2004/108/EG, med följande ändringar 93/68/EGW

EG-Lågspänningsdirektive 2006/95/EG med följande ändringar 93/68/EGW

Tillämpada harmoniserade normer, i synnerhet:<sup>1)</sup>

#### TR

##### EC Uygunluk Teyid Belgesi

Bu cihazın teslim edildiği şekilde aşağıdaki standartlara uygun olduğunu teyid ederiz:

Elektromanyetik Uyumluluk 2004/108/EG ve takip eden, 93/68/EGW

Açık gerilim direktifi 2006/95/EG ve takip eden, 93/68/EGW

Kisimen kullanılan standartlar:<sup>1)</sup>



723977